

Milling tools made by  
**JONGEN!**

**FACE MILLING**

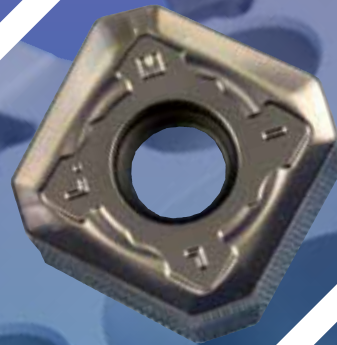

**A15**  
**Type**

## THE TOOL

- ☞ Especially efficient face milling cutter for the roughing and finishing machining
- ☞ Axial depth of cut max. 7 mm, with 8 effective cutting edges
- ☞ Tools are made of tempered and solid tool steel in order to resist highest charges
- ☞ Thanks to the nickel-coated surfaces of the tools, a higher resistance can be obtained against reweldings and corrosion

## CHARACTERISTICS

- ☞ Face milling tool designed for steel and cast iron processing
- ☞ The new generation of face mills has persuasive properties such as the number of cutting edges and soft cutting manner, caused by the positive rake angle and the good surface.
- ☞ Due to the positive geometry the tools are applicable at almost every kind of machine.
- ☞ Different versions of number of teeth allow an optimal choice for the required machining process.

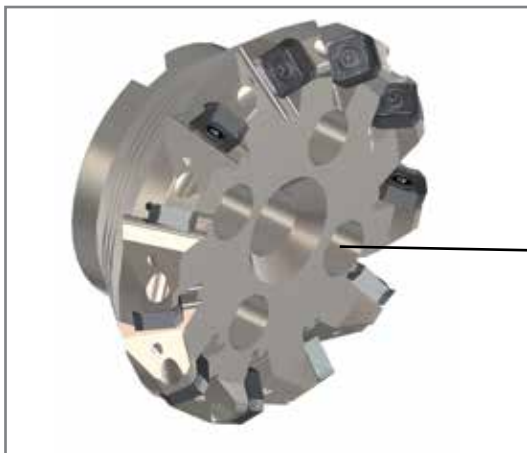
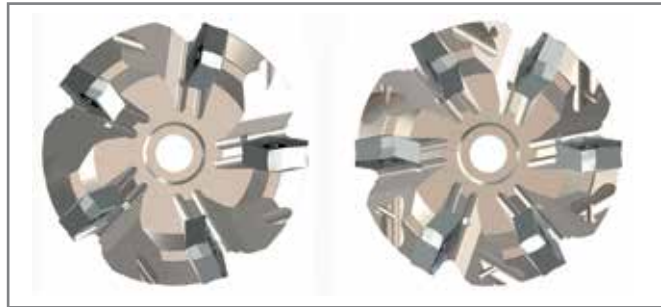

- ☞ Holders are made to DIN 8030. Starting from  $\varnothing 125$  the tools are equipped with supplementary boreholes for the corresponding tool holder.

supplementary boreholes from  $\varnothing 125$

- ☞ Face mills from  $\varnothing 50 - 100$  include internal coolant passages

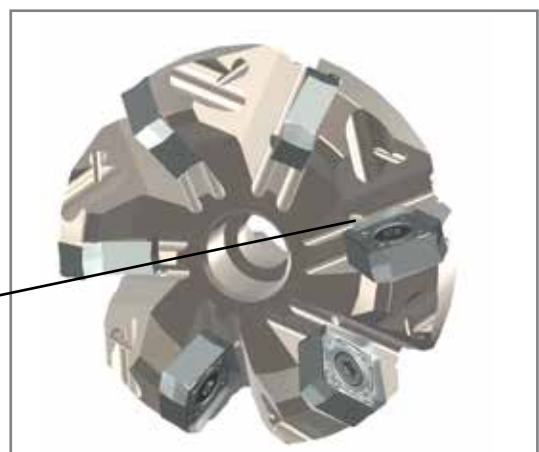

internal coolant passage

## THE INSERT

- ☞ Precision sintered, with 8 effective cutting edges  
axial depth of cut max. 7 mm

### JMA15-554

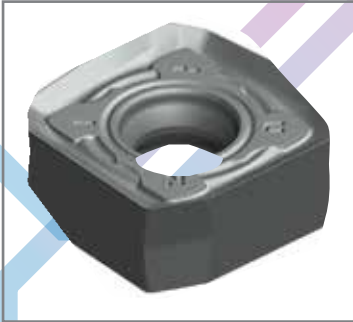

Precision sintered with highly positive chip breaker, chamfered and rounded edge.

### JMA15-754

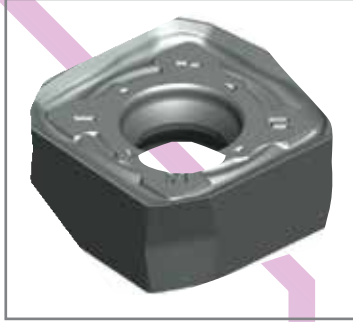

Precision sintered with highly positive chip breaker, chamfered and rounded edge, as alternative to the FP 554

### JMA15-454



Precision sintered, with chip breaker, chamfered and rounded edge. Qualified for robust machining, but needs more drive power.

- ☞ Application areas: all kind of steels and high-grade steels, hard-to-machine materials as well as cast iron materials.

#### Following carbide qualities are offered:

##### HT32



Code 33 - ISO-Classification M20 - M30

Hard wearing and tough finest grain carbide with a AlTiN- Nanocomposit-coating for middle – high cutting speeds and middle feed rates. This quality is suitable for dry milling and can also be adopted with cooling. Application areas are roughing and finishing high grade materials, tool steel and stainless steel.

##### HT45



Code 31 - ISO-Classification P30 - P35

Very tough fine grain carbide with a AlTiN- Nanocomposit-coating for middle – high cutting speeds and high feed rates. This quality is suitable for dry milling and can also be adopted with cooling. Application areas are roughing and finishing of almost all steels and cast iron qualities such as: Structural steel, tool steel, heat-treatable steel, as well as unalloyed steel, low alloyed steel, high alloyed steel and also grey cast iron, globular raphite cast iron etc.

##### HT20



Code 32 - ISO-Classification K15 - K20

Very hard wearing fine grain carbide with a AlTiN- Nanocomposit-coating for middle – high cutting speeds with high feed rates. This quality is suitable for dry milling and can also be adopted with cooling. Application areas are roughing and finishing of cast iron materials, e.g. grey-, tempered-, vermicular-, graphite- and globular graphite cast iron.



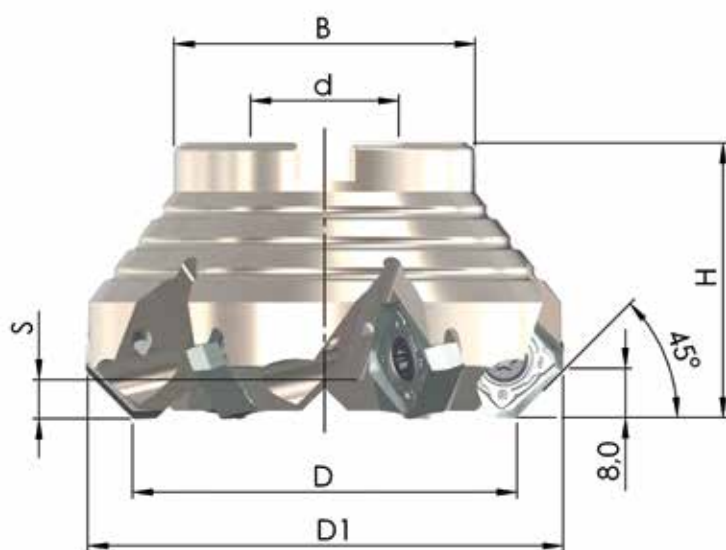













## TECHNICAL DATA



Order-Nr.	D	D <sub>1</sub>	H	d	B	S	Z	MS
45PP-050-554-4	50	64,2	45	22	46	6,3	4	MS 10x25-912
45PP-063-554-5	63	77,2	45	22	46	6,3	5	MS 10x25-912
45PP-080-554-6	80	94,2	55	27	58	6,3	6	MS 12x35-912
45PP-100-554-7	100	114,2	55	32	78	6,3	7	MS 16x35-6912
45PP-125-554-9	125	139,2	63	40	90	6,3	9	MS 20x55-7991
45PP-160-554-11	160	174,2	63	40	90	6,3	11	MS 20x55-7991
<b>Close pitch</b>								
45PP-050-554-5	50	64,2	45	22	46	6,3	5	MS 10x25-912
45PP-063-554-6	63	77,2	45	22	46	6,3	6	MS 10x25-912
45PP-080-554-7	80	94,2	55	27	58	6,3	7	MS 12x35-912
45PP-100-554-9	100	114,2	55	32	78	6,3	9	MS 16x35-6912
45PP-125-554-11	125	139,2	63	40	90	6,3	11	MS 20x55-7991
45PP-160-554-13	160	174,2	63	40	90	6,3	13	MS 20x55-7991



MS= Central screw

## INSERTS

			<b>HT45</b> (code 31)	<b>HT32</b> (code 33)	<b>HT20</b> (code 32)			
	<b>JMA15-554</b> (A15) IK=16,2 x 7,1							
		$f_z$ [mm]	0,20 (0,15-0,30)	0,20 (0,15-0,30)	0,30 (0,15-0,50)			
	<b>JMA15-754</b> (A15) IK=16,2 x 7,1							
		$f_z$ [mm]	0,20 (0,15-0,30)	0,20 (0,15-0,30)	0,30 (0,15-0,50)			
	<b>JMA15-454</b> (A15) IK=16,2 x 7,1							
		$f_z$ [mm]	0,30 (0,20-0,50)	0,30 (0,20-0,50)	0,40 (0,20-0,60)			
			10	10	10			

$V_c$ [m/min]	steel	stainless	cast iron	non-ferrous metals	highly heat-resistant	tempered
<b>HT45</b>	250 (200 - 350)	240 (140 - 300)	240 (130 - 280)			
<b>HT32</b>	250 (200 - 350)	240 (140 - 300)			60 (40 - 200)	
<b>HT20</b>			260 (180 - 350)			80 (40 - 120)

## SPARE PARTS

	<b>SS 5,0-4</b>	Tightening torque <b>4,8-5,0 Nm</b>	<b>Fixing screw</b>
	<b>T 20</b>		<b>Screw driver</b>
	<b>100 g</b>		<b>Heavy duty grease</b>

## ELECTION OF THE OPTIMAL TOOL

Optimal choice of tool diameter:

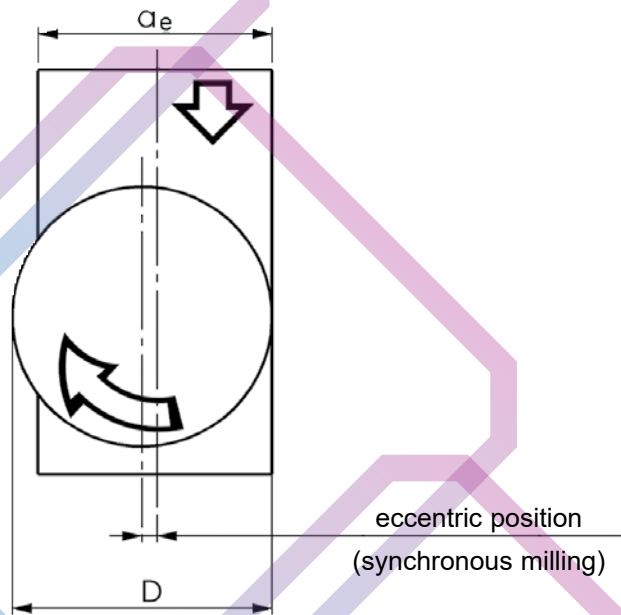

Calculation example:

$$a_e = 50 \text{ mm}$$

$$D = 50 \times 1,2 = 60$$

→ Here the correct tool diam. would be 63 mm.

$a_e$  = radial depth of cut

$D$  = tool diameter

Optimal choice of a tool type:

Regular pitch:

universal milling and application

Close pitch:

maximal number of teeth for high capacity under steady conditions

## FURTHER TECHNICAL INFORMATION

Calculation of rotation number of main spindle:

$$n = \frac{1000 \cdot v_c}{D \cdot \pi} \quad [\text{min}^{-1}]$$

$n$  = Rotation number ( $\text{min}^{-1}$ )

$v_c$  = Cutting speed (m/min)

$D$  = Diameter of a tool (mm)

Calculation of feed velocity:

$$v_f = f_z \cdot Z \cdot n \quad [\text{mm/min}]$$

$V_f$  = Total feed (mm/min)

$f_z$  = Feed rate per tooth (mm)

$Z$  = Number of teeth

$n$  = Rotation number ( $\text{min}^{-1}$ )



# NOTES

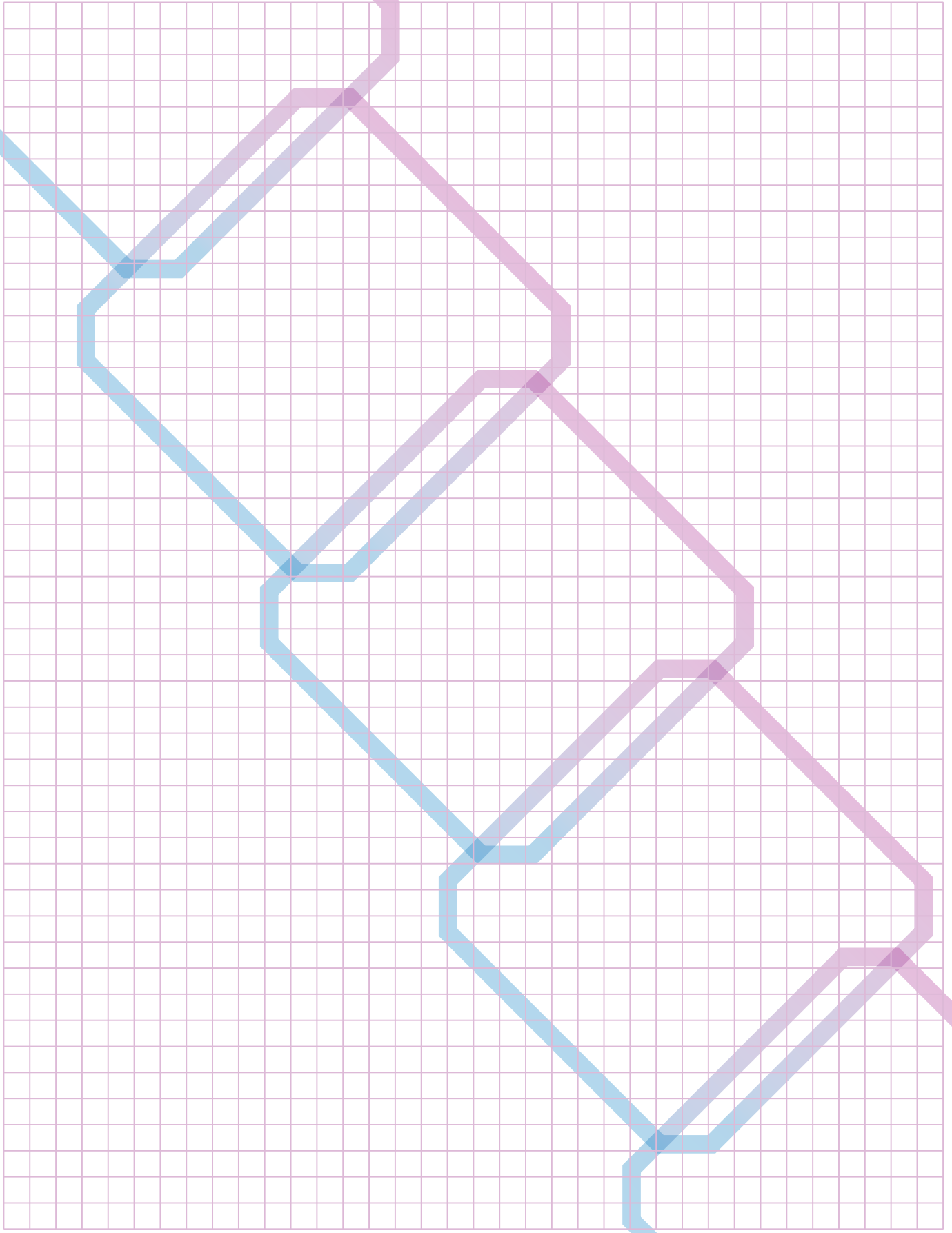

E & OE

01/18



## Jongen Werkzeugtechnik GmbH & Co. KG

Siemensring 11 · 47877 Willich · Germany  
Tel: 0049 2154 / 9285 2900 · Fax: 0049 2154 / 9285 9 2900  
www.jongen.de · email: [exportr@jongen.de](mailto:exportr@jongen.de)