

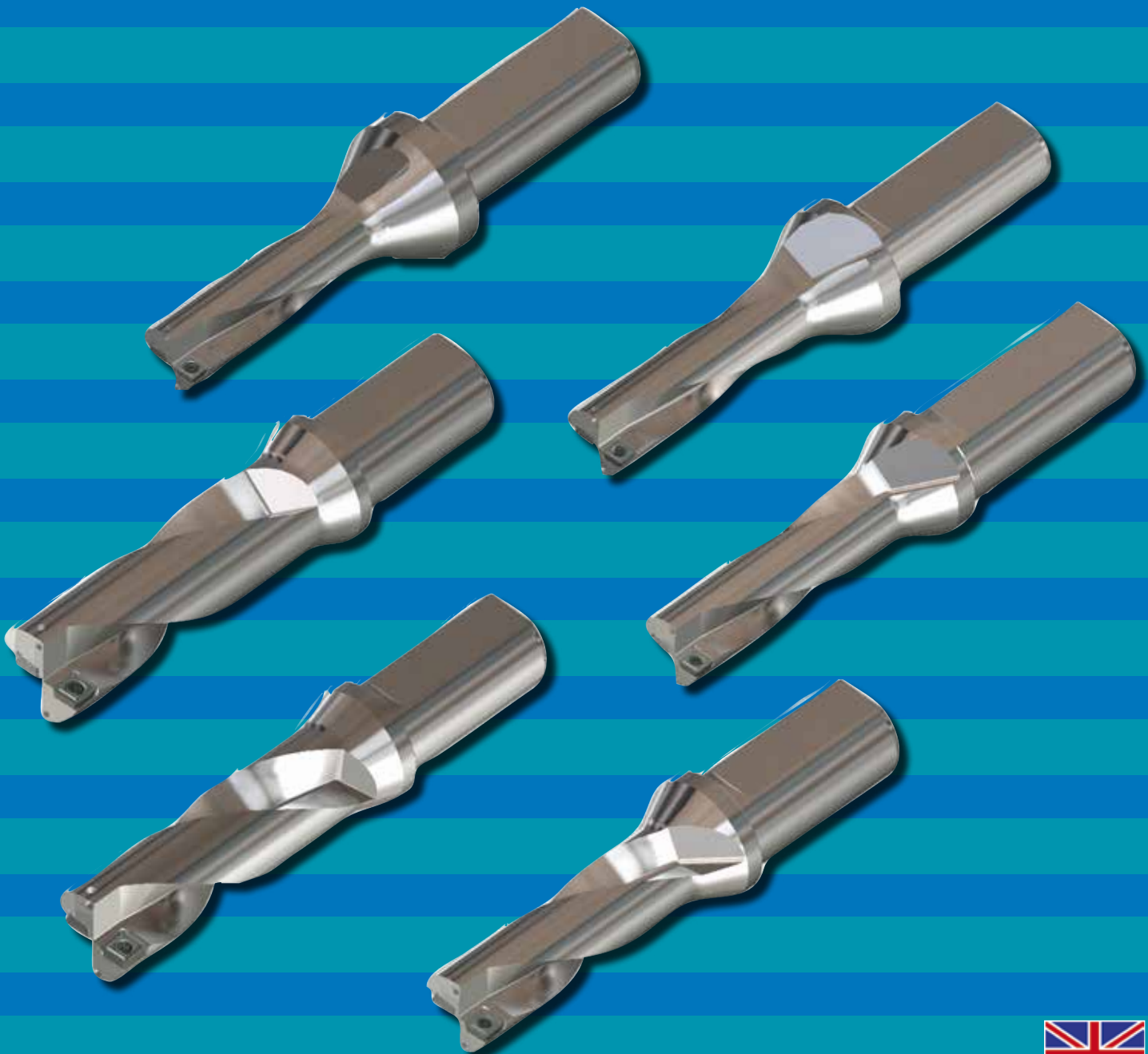

Jongen Werkzeugtechnik

Special Offer Autumn 2018

DRILLING TOOLS



Set BW 1 - Drilling Tool Type D01 (BP 04)

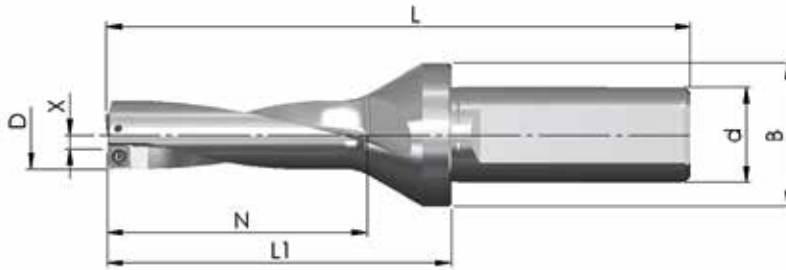

Article Code	D	N	L ₁	L	d _{h6}	B	Z	X max.	List prices
BW-14-42-20-04	14,0	42,0	69	119	20	30	1+1	0,25	203,00 €
BW-14,5-45-20-04	14,5	43,5	72	122	20	30	1+1	0,25	203,00 €
BW-15-45-20-04	15,0	45,0	72	122	20	30	1+1	0,25	203,00 €
BW-15,5-48-20-04	15,5	46,5	75	125	20	30	1+1	0,25	203,00 €
BW-16-48-20-04	16,0	48,0	75	125	20	30	1+1	0,25	203,00 €
10 pieces (1 packaging unit) JDD01-04T2R04-HT60 (BP 04T2 HT60)									76,50 €

Special Offer: ONE of the above listed drills with 1 packaging unit drilling inserts: 144,00 €

Set BW 2 - Drilling Tool Type D02 (BP 05)

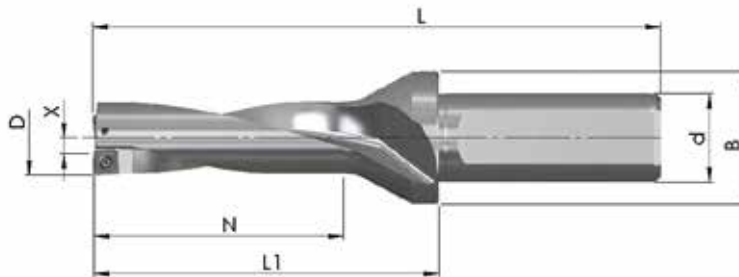

Article Code	D	N	L ₁	L	d _{h6}	B	Z	X max.	List prices
BW-16,5-51-20-05	16,5	49,5	78	128	20	30	1+1	0,40	203,00 €
BW-17-51-20-05	17,0	51,0	78	128	20	30	1+1	0,40	203,00 €
BW-17,5-54-20-05	17,5	52,5	81	131	20	30	1+1	0,40	203,00 €
BW-18-54-20-05	18,0	54,0	81	131	20	30	1+1	0,40	203,00 €
10 pieces (1 packaging unit) JDD02-05T2R04-HT60 (BP05T2 HT60)									78,50 €

Special Offer: ONE of the above listed drills with 1 packaging unit drilling inserts: 149,00 €

Set BW 3 - Drilling Tool Type D03 (BP 06)

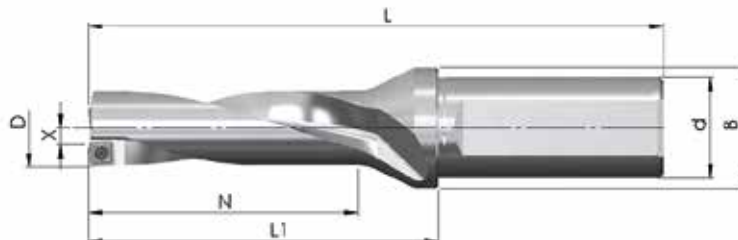

Article Code	D	N	L ₁	L	d _{h6}	B	Z	X max.	List prices
BW-18,5-57-25-06	18,5	55,5	84	140	25	30	1+1	0,5	203,00 €
BW-19-57-25-06	19,0	57,0	84	140	25	30	1+1	0,5	203,00 €
BW-19,5-60-25-06	19,5	58,5	87	143	25	30	1+1	0,5	203,00 €
BW-20-60-25-06	20,0	60,0	87	143	25	30	1+1	0,5	230,00 €
BW-20,5-63-25-06	20,5	61,5	90	146	25	30	1+1	0,5	230,00 €
10 pieces (1 packaging unit) JDD03-06T2R06-HT60 (BP 06T2 HT60)									82,00 €

Special Offer: ONE of the above listed drills with 1 packaging unit drilling inserts: 159,00 €

Set BW 4 - Drilling Tool Type D04 (BP 07)

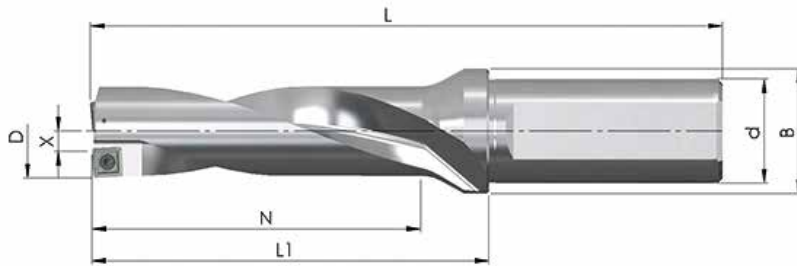

Article Code	D	N	L ₁	L	d _{h6}	B	Z	X max.	List prices
BW-21-63-25-07	21,0	63,0	90	146	25	30	1+1	0,5	230,00 €
BW-21,5-63-25-07	21,5	64,5	90	146	25	30	1+1	0,5	230,00 €
BW-22-66-25-07	22,0	66,0	92	148	25	30	1+1	0,5	230,00 €
BW-22,5-69-25-07	22,5	67,5	95	151	25	30	1+1	0,5	230,00 €
BW-23-69-25-07	23,0	69,0	95	151	25	30	1+1	0,5	230,00 €
BW-23,5-72-25-07	23,5	70,5	98	154	25	30	1+1	0,5	230,00 €
BW-24-72-25-07	24,0	72,0	98	154	25	30	1+1	0,5	230,00 €
10 pieces (1 packaging unit) JDD04-07T2R06-HT60 (BP 07T2 HT60)									83,00 €

Special Offer: ONE of the above listed drills with 1 packaging unit drilling inserts: 158,00 €

Set BW 5 - Drilling Tool Type D05 (BP 08)

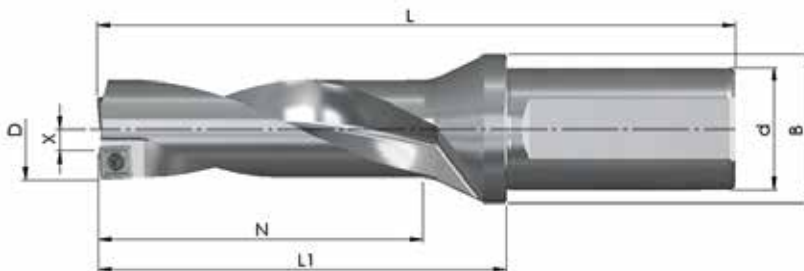

Article Code	D	N	L ₁	L	d _{h6}	B	Z	X max.	List prices
BW-24,5-75-32-08	24,5	73,5	101	161	32	39	1+1	0,5	230,00 €
BW-25-75-32-08	25,0	75,0	101	161	32	39	1+1	0,5	244,00 €
BW-25,5-78-32-08	25,5	76,5	104	164	32	39	1+1	0,5	244,00 €
BW-26-78-32-08	26,0	78,0	104	164	32	39	1+1	0,5	244,00 €
BW-26,5-81-32-08	26,5	79,5	107	167	32	39	1+1	0,5	244,00 €
BW-27-81-32-08	27,0	81,0	107	167	32	39	1+1	0,5	244,00 €
BW-28-84-32-08	28,0	84,0	110	170	32	39	1+1	0,5	244,00 €
10 pieces (1 packaging unit) JDD05-08T3R08-HT60 (BP 08T3 HT60)									88,50 €

Special Offer: ONE of the above listed drills with 1 packaging unit drilling inserts: 168,00 €

Set BW 6 - Drilling Tool Type D06 (BP 10)

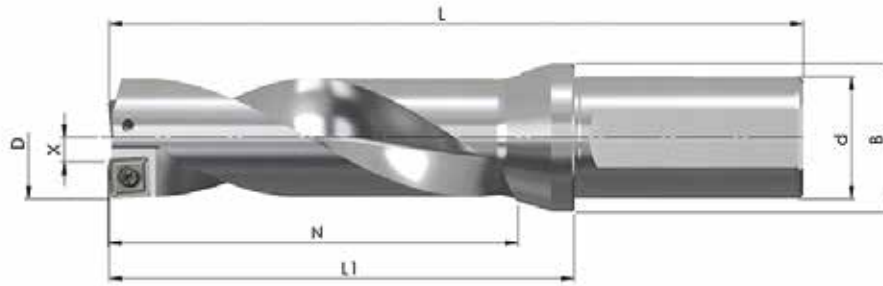

Article Code	D	N	L ₁	L	d _{h6}	B	Z	X max.	List prices
BW-29-87-32-10	29,0	87	113	173	32	39	1+1	0,5	244,00 €
BW-30-90-32-10	30,0	90	116	176	32	39	1+1	0,5	244,00 €
BW-31-93-32-10	31,0	93	119	179	32	39	1+1	0,5	244,00 €
BW-32-96-32-10	32,0	96	122	182	32	39	1+1	0,5	244,00 €
BW-33-99-32-10	33,0	99	125	185	32	39	1+1	0,5	244,00 €
BW-34-102-32-10	34,0	102	128	188	32	39	1+1	0,5	244,00 €
10 pieces (1 packaging unit) JDD06-10T4R08-HT60 (BP 10T4 HT60)									101,50 €

Special Offer: ONE of the above listed drills with 1 packaging unit drilling inserts: 189,00 €

Set BW 7 - Drilling Tool Type D07 (BP 12)

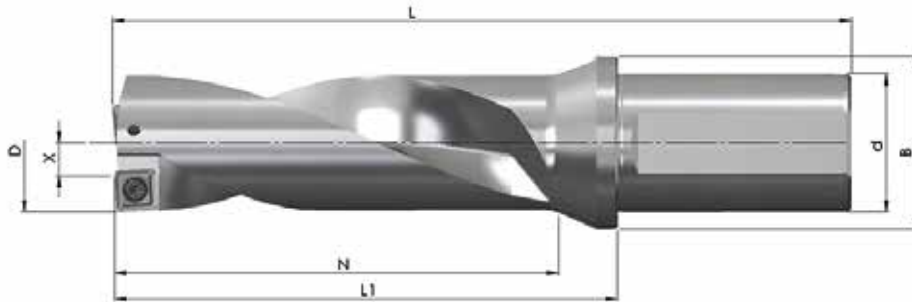

Article Code	D	N	L ₁	L	d _{h6}	B	Z	X max.	List prices
BW-35-105-40-12	35,0	105	131	199	40	50	1+1	0,5	244,00 €
BW-36-108-40-12	36,0	108	134	202	40	50	1+1	0,5	244,00 €
BW-37-111-40-12	37,0	111	137	205	40	50	1+1	0,5	285,00 €
BW-38-114-40-12	38,0	114	140	208	40	50	1+1	0,5	285,00 €
BW-39-117-40-12	39,0	117	143	211	40	50	1+1	0,5	285,00 €
BW-40-120-40-12	40,0	120	146	214	40	50	1+1	0,5	285,00 €
BW-41-123-40-12	41,0	123	149	217	40	50	1+1	0,5	285,00 €
BW-42-126-40-12	42,0	126	152	220	40	50	1+1	0,5	285,00 €
BW-43-129-40-12	43,0	129	155	223	40	50	1+1	0,5	285,00 €
BW-44-132-40-12	44,0	132	158	226	40	50	1+1	0,5	285,00 €
10 pieces (1 packaging unit) JDD07-12T5R08-HT60 (BP 12T5 HT60)									110,00 €

Special Offer: ONE of the above listed drills with 1 packaging unit drilling inserts: 218,00 €

The special offer is valid till 31.01.2019, or while stocks last.

Only complete sets for sale, as indicated in this brochure and at market usual order quantities.

Errors and omissions are reserved